

Detailed Installer Guide

Non-Programmable Thermostats

3020 Single Stage Heat / Cool Conventional
or Heat Pump

3220 Up to 3 Heat / 2 Cool Heat Pump
Up to 2 Heat / 2 Cool Conventional

Model number is located on back of thermostat.

1 Specifications 2 Installation and Wiring 3 Quick Reference
4 Installer Settings 5 System Testing



Warning *For installation by experienced service technicians only.*



Caution • Possible electric shock or damage to equipment can occur.
• Disconnect power before beginning installation.

This thermostat requires 24 Volt AC Power or 2 properly installed “AA” Alkaline batteries for proper operation. When connecting 24 Volt AC Power the batteries may be installed as a backup.

For use only as described in this manual. Any other use will void warranty.

1 Specifications

This thermostat is compatible with:

- Single stage heat / cool conventional and heat pump systems
- Conventional systems up to 2 stages of heating and 2 stages of cooling (3220 only)
- Heat pump systems up to 3 stages of heating and 2 stages of cooling (3220 only)
- 250 – 750 millivolt heating only systems
- 2 or 3 wire hydronic zone systems

Electrical and control specifications:

- Electrical Rating: 24 Volt AC
- 1 amp maximum load per terminal
- AC Power: 18 – 30 Volts AC
- DC Power: 3.0 Volt DC (2 “AA” Alkaline Batteries Included)
- Control Range: 45° – 90° F (7° – 32° C)
- Temperature Accuracy: +/- 1° F (+/- .5° C)
- Outdoor Temperature Display Range: -40° - 120° F (-40° - 49° C)

Terminations

- 3020: G, Rc, Rh, W1, O/B/V3, Y1, C, S1, S2
- 3220: G, Rc, Rh, W1/E/W3, W2, O/B/V3, Y1, Y2, C, L, S1, S2

2 Installation and Wiring

Warning *Disconnect power before beginning installation.*

Thermostat Location

Install the thermostat approximately 5 feet (1.5m) above the floor in an area that has a good amount of air circulation and maintains an average room temperature.

Avoid installation in locations where the thermostat can be affected by drafts, dead air spots, hot or cold air ducts, sunlight, appliances, concealed pipes, chimneys and outside walls.

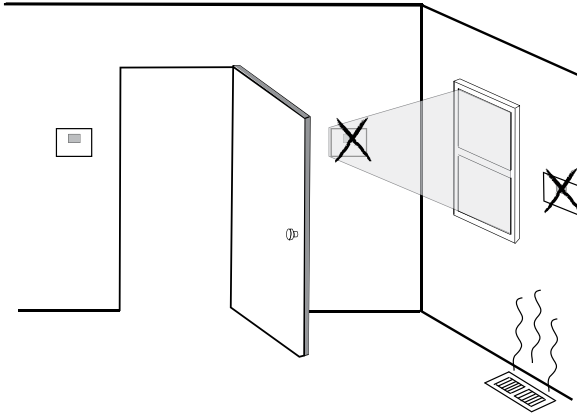

Install your new Braeburn thermostat in 4 basic steps:

- 1 Install the Sub-Base
- 2 Provide Power
- 3 Connect Your Wires
- 4 Attach Thermostat to Sub-Base

1 Install the Sub-Base:

- Remove the sub-base from the body of the thermostat.
- Mount the sub-base as shown below:

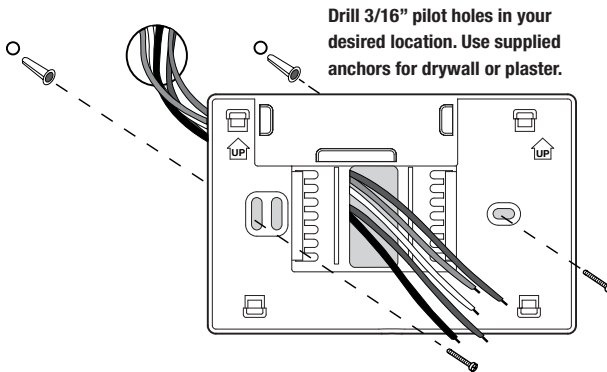

2 Provide Power

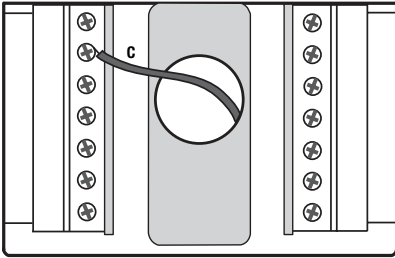

24VAC Power Terminal (C)

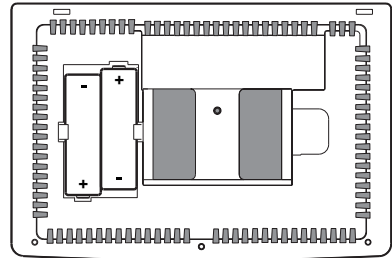

Batteries Installed as Shown

- For 24 Volt AC power, you must connect the common side of the transformer to the C terminal on the thermostat sub-base. In dual transformer installations, the transformer common must come from the cooling transformer.
- For battery power, insert the 2 supplied “AA” type alkaline batteries into the battery compartment located in the rear housing of the thermostat. Make sure to position the Positive (+) and Negative (-) sides of the batteries correctly with the +/- symbols in the battery compartment.

3 Connect Your Wires

Wiring Terminations for model 3020

Terminal	Function	Description
Rc	Input	24 Volt AC Cooling Transformer (Dual Transformer Systems Only)
Rh	Input	Power Connection (24 Volt AC Heating Transformer or Millivolt Power Source)
G	Output	Fan Control
W1	Output	Conventional Heat Relay
O / B / V3	Output	(O) Cool Active Reversing Valve (B) Heat Active Reversing Valve (V3) Zone Valve Power Close
Y1	Output	Compressor Relay
C	Input	24 Volt AC Transformer Common
S1	Input	Optional Remote Sensor (indoor or outdoor)
S2		

3 Connecting Your Wires (continued)

Wiring Terminations for model 3220

Terminal	Function	Description
Rc	Input	24 Volt AC Cooling Transformer (Dual Transformer Systems Only)
Rh	Input	Power Connection (24 Volt AC Heating Transformer or Millivolt Power Source)
G	Output	Fan Control
W1 / E / W3	Output	(W1) 1st Stage Conventional Heat, (E) Emergency Heat, (W3) 3rd Stage Auxiliary Heat
W2	Output	2nd Stage Conventional Heat
O / B / V3	Output	(O) Cool Active Reversing Valve (B) Heat Active Reversing Valve (V3) Zone Valve Power Close
Y1	Output	1st Stage Compressor
Y2	Output	2nd Stage Compressor
L	Input	System Malfunction Indicator
C	Input	24 Volt AC Transformer Common
S1	Input	Optional Remote Sensor (indoor or outdoor)
S2		

Conventional Systems

Typical Wiring Configurations

NOTE: The “System Type” option will be configured in the Installer Settings section. The 3020 is a single stage thermostat and not intended for multi stage equipment.

Heat Only or Millivolt

Set System Type to **11CONV**

Rh	Power Connection
W1	Heat Relay
G	Fan Relay [note 4]
C	24 Volt AC Transformer Common [note 1]

1 HEAT / 1 COOL Single or Dual Transformer

Set System Type to **11CONV**

Rh	24 Volt AC Power (heating transformer) [note 2]
Rc	24 Volt AC Power (cooling transformer) [note 2]
W1	Heat Relay
Y1	Compressor Relay
G	Fan Relay
C	24 Volt AC Transformer Common [note 1, 3]

2 HEAT / 2 COOL Single or Dual transformer

Set System Type to **22CONV**

Rh	24 Volt AC Power (heating transformer) [note 2]
Rc	24 Volt AC Power (cooling transformer) [note 2]
W1	Heat Relay Stage 1
W2	Heat Relay Stage 2
Y1	Compressor Relay Stage 1
Y2	Compressor Relay Stage 2 [note 4]
G	Fan Relay
C	24 Volt AC Transformer Common [note 1, 3]

Additional Wiring Options

NOTE: Additional options are configured in the Installer Settings section.

S1	Indoor or Outdoor Remote Sensor [note 1]
S2	

Hydronic Heat Only

Set System Type to **1HD**

Rh	24 Volt AC Power (heating transformer)
W1	Zone Valve Power Open
V3	Zone Valve Power Close
G	Fan Relay [note 4]
C	24 Volt AC Transformer Common [note 1]

Hydronic Heat / 1 Cool

Set System Type to **11HD**

Rh	24 Volt AC Power (heating transformer) [note 2]
Rc	24 Volt AC Power (cooling transformer) [note 2]
W1	Zone Valve Power Open
V3	Zone Valve Power Close
Y1	Compressor Relay
G	Fan Relay (cooling fan only)
C	24 Volt AC Transformer Common [note 1, 3]

NOTES - Conventional Systems

- [1]** Optional 24 Volt AC common connection.
- [2]** Remove factory installed jumper for dual transformer systems.
- [3]** In dual transformer systems, transformer common must come from cooling transformer.
- [4]** If needed for system.

Provide disconnect and overload protection as required.

NOTES - Additional Wiring Options

- [1]** These terminals can be used to connect a Braeburn® indoor or outdoor remote sensor.

Heat Pump Systems

Typical Wiring Configurations

NOTE: The “System Type” option will be configured in the Installer Settings section. The 3020 is a single stage thermostat and not intended for multi stage equipment.

1 HEAT / 1 COOL - No Auxiliary Heat

Set System Type to **11HP**

Rh	24 Volt AC Power
Rc	Connected to Rh with supplied Jumper Wire
O/B	Changeover Valve [note 2]
Y1	Compressor Relay
G	Fan Relay
C	24 Volt AC Transformer Common [note 1]

2 HEAT / 2 COOL - No Auxiliary Heat

Set System Type to **32HP**

Rh	24 Volt AC Power
Rc	Connected to Rh with supplied Jumper Wire
O/B	Changeover Valve [note 2]
Y1	Compressor 1 Relay (1st stage heating/cooling)
Y2	Compressor 2 Relay (2nd stage heating/cooling)
G	Fan Relay
C	24 Volt AC Transformer Common [note 1]
L	Optional System Fault Monitor [note 4]

2 HEAT / 1 COOL - Including Auxiliary Heat

Set System Type to **22HP**

Rh	24 Volt AC Power
Rc	Connected to Rh with supplied Jumper Wire
O/B	Changeover Valve [note 2]
Y1	Compressor Relay (1st stage heating/cooling)
W2	Auxiliary Heat Relay (2nd stage heating) [note 3]
E	Emergency Heat Relay [note 3]
G	Fan Relay
C	24 Volt AC Transformer Common [note 1]
L	Optional System Fault Monitor [note 4]

3 HEAT / 2 COOL – Including Auxiliary Heat

Set System Type to **32HP**

Rh	24 Volt AC Power
Rc	Connected to Rh with supplied Jumper Wire
O/B	Changeover Valve [note 2]
Y1	Compressor 1 Relay (1st stage heating/cooling)
Y2	Compressor 2 Relay (2nd stage heating/cooling)
E/W3	Auxiliary Heat Relay (3rd stage heating) [note 5]
G	Fan Relay
C	24 Volt AC Transformer Common [note 1]
L	Optional System Fault Monitor [note 4]

NOTES - Heat Pump Systems

- [1]** Optional 24 Volt AC common connection.
- [2]** O (cool active) or B (heat active) is selected in the Installer Settings menu.
- [3]** Install a field supplied jumper between the W2 and W1/E/W3 terminals if there is no separate emergency heat relay installed.
- [4]** If the L terminal is used, the 24 Volt AC common must be connected (C terminal).
- [5]** If a separate emergency heat relay is installed, the W1/E/W3 terminal should have both the auxiliary heat 1 relay and emergency heat relay connected.

Provide disconnect and overload protection as required.

Additional Wiring Options

NOTE: Additional options are configured in the Installer Settings section.

S1	Indoor or Outdoor Remote Sensor [note 1]
S2	

NOTES - Additional Wiring Options

- [1]** These terminals can be used to connect a Braeburn® indoor or outdoor remote sensor.

4 Attach Thermostat to Sub-Base

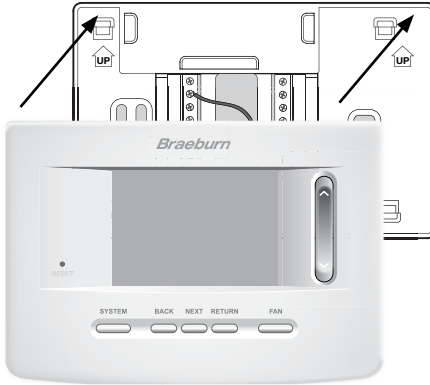

- 1) Line up the thermostat body with the sub-base.
- 2) Carefully push the thermostat body against the sub-base until it snaps in place.



- 3) Insert Quick Reference Card into slot on top of thermostat.

NOTE: This thermostat ships configured as a 1H/1C conventional thermostat. Confirm installer settings. See page 9.

3 Quick Reference

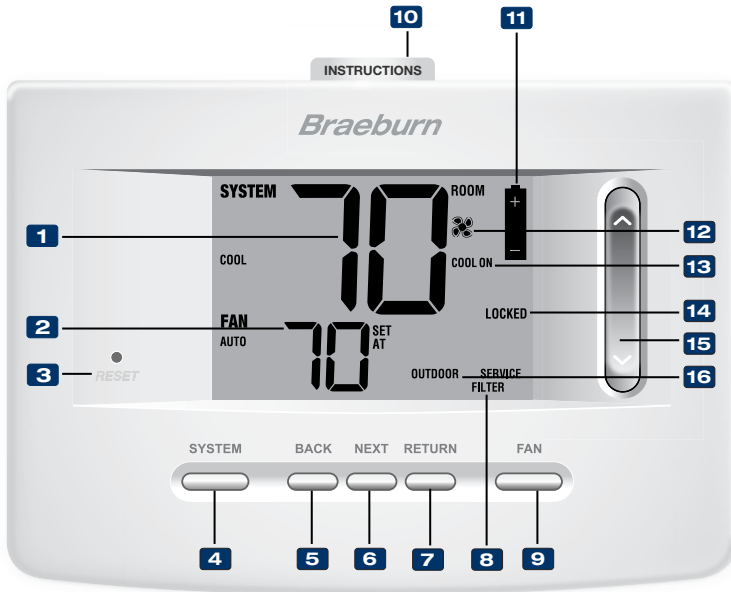

Thermostat and Display

- 1 Room Temperature** Displays the current room temperature
 - 2 Set Temperature** Displays the current set point temperature
 - 3 Reset Button** Resets current time, program and user settings
 - 4 SYSTEM Button** Selects the system you want to control
 - 5 BACK Button** Moves back in installer/user setup modes
 - 6 NEXT Button** Moves forward in installer/user setup modes
 - 7 RETURN Button** Returns to normal mode from installer/user setup modes
 - 8 Service Indicators** Displays various service/maintenance information
 - 9 FAN Button** Selects the system fan mode
 - 10 Quick Reference Instructions** Stored in slot located at top of thermostat
 - 11 Low Battery Indicator** Indicates when the batteries need to be replaced
 - 12 Fan Indicator** Indicates when the system fan is running
 - 13 System Status Indicator** Displays information about the status of the system
 - 14 Lock Mode Indicator** Indicates if the thermostat is locked
 - 15 SpeedBar®** Increases or decreases settings (time, temperature, etc.)
 - 16 Outdoor Temperature Indicator** Displays along with the outdoor temperature reading (see note below)
- Battery Compartment** Located in the back of thermostat

***NOTE:** If a Braeburn® outdoor sensor was connected you can view the outdoor temperature by pressing the **BACK** and **NEXT** buttons at the same time.*

4 Installer Settings

The Installer Settings must be properly configured in order for this thermostat to operate correctly. The Installer Settings are menu driven. The portion of these settings that do not apply to your setup will be skipped. These settings are indicated below with comments. More detail on each setting follows this table.

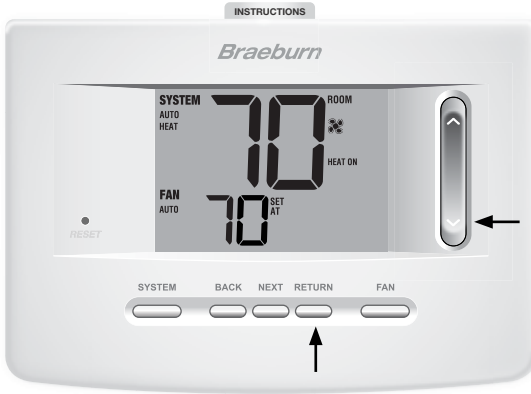

1. Press and hold down the **RETURN** and **V** buttons for 3 seconds.
2. Release both buttons and the first installer setting will be displayed.
3. Change settings as required using the **▲** or **▼** portion of the SpeedBar®.
4. Press **NEXT** or **BACK** to move to the next or previous setting, press **RETURN** to exit.

NOTE: Shaded areas below do not apply to the 3020.

No.	Installer Setting (Notes follow this table)	Factory Default	Setting Options	Comments (More information follows this table)
1	Temperature Scale	F DEG	F DEG C DEG	Select for Fahrenheit display Select for Celsius display
2	Auto Changeover	oF AUTO	oF AUTO oN AUTO	Disables Auto Changeover mode Enables Auto Changeover mode
3	System Type	11CONV	11CONV	Select for 1H/1C Conventional system
			22CONV	Select for 2H/2C Conventional system
			11HP	Select for 1H/1C Heat Pump system
			22HP	Select for 2H/2C Heat Pump system
			32HP	Select for 3H/2C Heat Pump system
4	1st Stage Differential	0.5 DIF1	11HD	Select for Heat Only Hydronic system
			11HD	Select for Hydronic Heat/1C system
5	2nd Stage Differential [note 1]	2.0 DIF2	1.0, 2.0, 3.0, 4.0, 5.0 or 6.0 DIF2	Select a 2nd stage temperature differential of 1°, 2°, 3°, 4°, 5° or 6° F (0.5°, 1°, 1.5°, 2°, 2.5° or 3° C)
6	3rd Stage Differential [note 1]	2.0 DIF3	1.0, 2.0, 3.0, 4.0, 5.0 or 6.0 DIF3	Select a 3rd stage temperature differential of 1°, 2°, 3°, 4°, 5° or 6° F (0.5°, 1°, 1.5°, 2°, 2.5° or 3° C)
7	1st Stage Fan Control [note 2]	HG FAN 1	HG FAN 1 HE FAN 1	Select for 1st stage Gas heating Select for 1st stage Electric heating
8	Emergency Heat] Fan Control [note 3]	HE EMER	HE EMER HG EMER	Select for Electric Emergency Heat Select for Gas Emergency Heat
9	Reversing Valve (O/B Terminal) [note 4]	REVB	REVB REVB	Select for cool active Reversing Valve (O terminal) Select for heat active Reversing Valve (B terminal)
10	Fossil Fuel Backup Heat [note 3]	RE AUX	RE AUX	Select for Electric Auxiliary heat (with compressor)
			RG AUX	Select for Gas Auxiliary heat (without compressor)

No.	Installer Setting (Notes follow this table)	Factory Default	Setting Options	Comments (More information follows this table)
11	Compressor Power Outage Protection [notes 3, 5]	oF CPOD	oF CPOD oN CPOD	Disables Power Outage Lockout Delay Enables Power Outage Lockout Delay
12	AC Power Interrupt Warning [note 5]	oF oN oNR	oF oF oNR oN oN oNR	Disables AC Power Interrupt Warning Enables AC Power Interrupt Warning
13	Compressor Short Cycle Protection [note 6]	5 CSCP	5, 4, 3, 2 or 0 CSCP	Select a compressor short cycle protection delay of 5, 4, 3, 2 or 0 minutes
14	Residual Cooling Fan Delay [note 6]	60 FAN	90, 60, 30 or 0 FAN	Select a Residual Cooling Fan Delay of 90, 60, 30 or 0 seconds.
15	Indoor Remote Sensor Control* [note 7]	1 SENS	1 SENS E SENS A SENS	Temperature is sensed from thermostat only. Temperature is sensed from remote sensor only. Temperature is combined with the thermostat and the remote sensor.
16	Lockout Security Level	2 LOCK	2 LOCK 1 LOCK	If locked – Complete lockout is enabled If locked – Partial lockout is enabled (SpeedBar® is still functional)
17	Auto Changeover Dead Band [note 8]	3 BRAND	2, 3, 4 or 5 BRAND	Select a Dead Band of 2°, 3°, 4° or 5° F (1°, 2° or 3° C) for Auto Changeover mode.
18	Compressor Balance Point [notes 3, 9]	NO BALC	NO BALC	Disables Balance Points
			15-50 BALC	Select a Compressor Balance Point of 15°- 50°F (-9°-10° C)
19	Auxiliary Heat Balance Point [notes 3, 9]	NO BALA	NO BALA	Disables Balance Points
			70-40 BALA	Select a Auxiliary Heat Balance Point of 70°- 40° F (21°- 4° C)
20	Heat Set Point Upper Limit	90 LiF	90-60 LiF	Select a Heat Set Point Upper Limit of 90°-60° F (32°-10° C)
21	Cool Set Point Lower Limit [note 6]	45 LiF	45-80 LiF	Select a Cool Set Point Lower Limit of 45°-80° F (7°-27° C)

*When a Braeburn® outdoor sensor is connected, the thermostat automatically recognizes it. Press **BACK** and **NEXT** at the same time to display outdoor temperature.

NOTE: Additional options such as Service Monitors, Setting the lock code, etc. are located in the User Settings – See User manual for information on setting these options.

NOTES - Installer Settings

- 1 Only available if a 2 or 3 stage system type was selected in option 3.
- 2 Only available if a Conventional system was selected in option 3.
- 3 Only available if a 2 or 3 stage Heat Pump system was selected in option 3.
- 4 Only available if a Heat Pump system was selected in option 3.
- 5 Only available if the 24 Volt AC common wire is connected to the C terminal.
- 6 Not available if a Heat Only Hydronic system is selected in option 3.
- 7 Only available if a Braeburn® indoor remote sensor was connected.
- 8 Only available if auto changeover was enabled in option 2.
- 9 Only available if a Braeburn outdoor sensor was connected.

Detailed Explanation of Installer Settings (also see NOTES above):

- 1 **Temperature Scale** – Selects a temperature scale of either °F or °C.
- 2 **Auto Changeover** – Selects auto changeover on or off. When auto changeover mode is enabled and selected, the system automatically switches between heating and cooling modes. There is a 5 minute delay when switching from heating to cooling or cooling to heating in auto changeover mode.
NOTE: Also see “Auto Changeover Dead Band” in option 17.

- 3 System Type** – Selects the system type for your installation. **NOTE:** *Changes made to this option will reset options 4 through 11 back to their default values dependant on the system type.*
- 4 1st Stage Differential** – Selects a 1st stage temperature differential.
- 5 2nd Stage Differential [note 1]** – Selects a 2nd stage temperature differential.
- 6 3rd Stage Differential [note 1]** – Selects a 3rd stage temperature differential.
- 7 1st Stage Fan Control [note 2]** – Selects a 1st stage fan control of either gas or electric heat.
- 8 Emergency Heat Fan Control [note 3]** – Selects emergency heat fan control of either gas or electric heat.
- 9 Reversing Valve [note 4]** – Selects the output state of the O/B terminal. Select 0 for this terminal to be active in the cool mode or select B for this terminal to be active in the heat mode.
- 10 Auxiliary Fossil Fuel Heat Pump Control [note 3]** – When set to electric (AE AUX), both the compressor (1st stage) and auxiliary stage(s) will run when a call for auxiliary heat is made. When set to gas (AG AUX), the compressor stage(s) will be locked out one minute after a call for auxiliary heat. **NOTE:** *This option can be overridden if setting an auxiliary heat balance point in Option 19.*
- 11 Compressor Power Outage Protection [notes 3, 5]** – Selects power outage protection on or off. When enabled, this thermostat will provide cold weather compressor protection by locking out the compressor stage(s) of heating for a period of time after a power outage greater than 60 minutes.
- 12 AC Power Interrupt Warning [note 5]** – When enabled, the thermostat will display an outage warning when AC power to the thermostat is lost.
- 13 Short Cycle Protection [note 6]** – Selects the number of minutes the cooling compressor will be locked out after turning off. This short cycle protection is also active in the heat mode if a heat pump system was selected in Option 3.
- 14 Residual Cooling Fan Delay [note 6]** – Selects a delay for the system fan after the cooling compressor has turned off. This delay will help remove the remaining cool air out of the ductwork providing additional efficiency.
- 15 Indoor Remote Sensor Control [note 7]** – If a Braeburn® indoor remote sensor is connected during installation, the thermostat will automatically detect the sensor. When an indoor sensor is detected, you may select between thermostat only (I SENS), remote sensor only (E SENS) or combining the thermostat and the remote sensor (A SENS). **NOTE:** *This option does not apply to a Braeburn outdoor sensor. When an outdoor sensor is connected the thermostat automatically recognizes it and no further configuration is necessary.*
- 16 Lockout Security Level** – Selects the level of keypad lockout when the thermostat is locked. Level 2 locks the entire thermostat (including the front reset button). Level 1 locks everything except the SpeedBar® allowing for up and down temperature adjustment. **NOTE:** *The lock code is set in the User Settings mode (see User Manual).*
- 17 Auto Changeover Dead Band [note 8]** – When auto changeover mode is enabled in option 2 and selected, the system automatically switches between heating and cooling when the room temperature meets the normal criteria for either a heating or cooling call. There is a forced separation (dead band) between the heating and cooling set points so that the systems do not work against each other. This option selects the amount of this dead band in degrees with the default being 3° F.
- 18 Compressor Balance Point [notes 3, 9]** – Locks out the use of the compressor heat stage when the outside air temperature is less than the selected setting of 15° F to 50° F (-9° C to 10° C).
- 19 Auxiliary Heat Balance Point [notes 3, 9]** – Locks out the use of the auxiliary heat stage when the outside air temperature exceeds the selected setting of 70° F to 40° F (21° C to 4° C). **NOTE:** *This balance point overrides the fossil fuel compressor lockout in option 10. If this option is set to gas and the outdoor temperature is over the auxiliary balance point, the compressor will remain on during a call for auxiliary heat.*

20 Heat Set Point Upper Limit – Selects the heating set point upper adjustment limit.

21 Cool Set Point Lower Limit [note 6] – Selects the cooling set point lower adjustment limit.

5 System Testing



Warning *Read Before Testing*

- Do not short (or jumper) across terminals on the gas valve or at the heating or cooling system control board to test the thermostat installation. This could damage the thermostat and void the warranty.
- Do not select the COOL mode of operation if the outside temperature is below 50° F (10° C). This could possibly damage the controlled cooling system and may cause personal injury.
- This thermostat includes an automatic compressor protection feature to avoid potential damage to the compressor from short cycling. When testing the system, make sure to take this delay into account.

NOTE: *The compressor delay can be bypassed by pressing the reset button on the front of the thermostat. All user settings will be returned to factory default, however all Installer settings will remain as originally programmed in section 4.*

- 1 Press the **SYSTEM** button until the thermostat is in HEAT mode.
- 2 Using the SpeedBar® raise the set temperature a minimum of 3 degrees above the current room temperature. The system should start within a few seconds. With a gas heating system, the fan may not start right away.
- 3 Press **SYSTEM** until the thermostat is in the OFF mode. Allow the heating system to fully shut down.
- 4 Press **SYSTEM** until the thermostat is in the COOL mode.
- 5 Using the SpeedBar lower the set temperature a minimum of 3 degrees below the current room temperature. The system should start within a few seconds (unless compressor short cycle protection is active – See note above).
- 6 Press **SYSTEM** until the thermostat is in the OFF mode. Allow the cooling system to fully shut down.
- 7 Press **FAN** until the thermostat is in FAN ON mode. The system fan should start within a few seconds.
- 8 Press **FAN** until the thermostat is in FAN AUTO mode. Allow the system fan to turn off.

Limited Warranty

When installed by a professional contractor, this product is backed by a 5 year limited warranty. Limitations apply. For limitations, terms and conditions, you may obtain a full copy of this warranty:

- Visit us online: www.braeburnonline.com/warranty
- Phone us: 866.268.5599
- Write us: Braeburn Systems LLC
2215 Cornell Avenue
Montgomery, IL 60538



Store this manual for future reference.

Braeburn®

Braeburn Systems LLC
2215 Cornell Avenue • Montgomery, IL 60538
Technical Assistance: www.braeburnonline.com
Call us toll-free: 866-268-5599 (U.S.)
630-844-1968 (Outside the U.S.)